

A CADET PUBLICATION FOR CADETS

HEE HEE HEE...  
CADET SCHYZKIBI?  
THIS IS YOUR  
COURSE DIRECTOR...  
(SNICKER SNICKER)  
..YEAH... PHYSICS...YEAH.  
HEE HEE HEE HEE...

THE  
Doob



AFGRP 190-4, DEC 64

No. 3

# the Doo Staff



OIC  
Capt Turner

EDITOR  
Dave Connaughton '85

Contributors:

Wayne Arnold	'65
Don Thompson	'66
Dutch Berkley	'66
JT. Swan	'65
Bob Resling	'67
Jim Richey	'67
Bob Lambert	'65
Bob McNameara	'66

Reb Phillips	'65
Buddy Martin	'67
Bob Boots	'68
Jesse Cogley	'66
Rick Russell	'68
Jim Baxas	'67
Tim Wheeler	'65

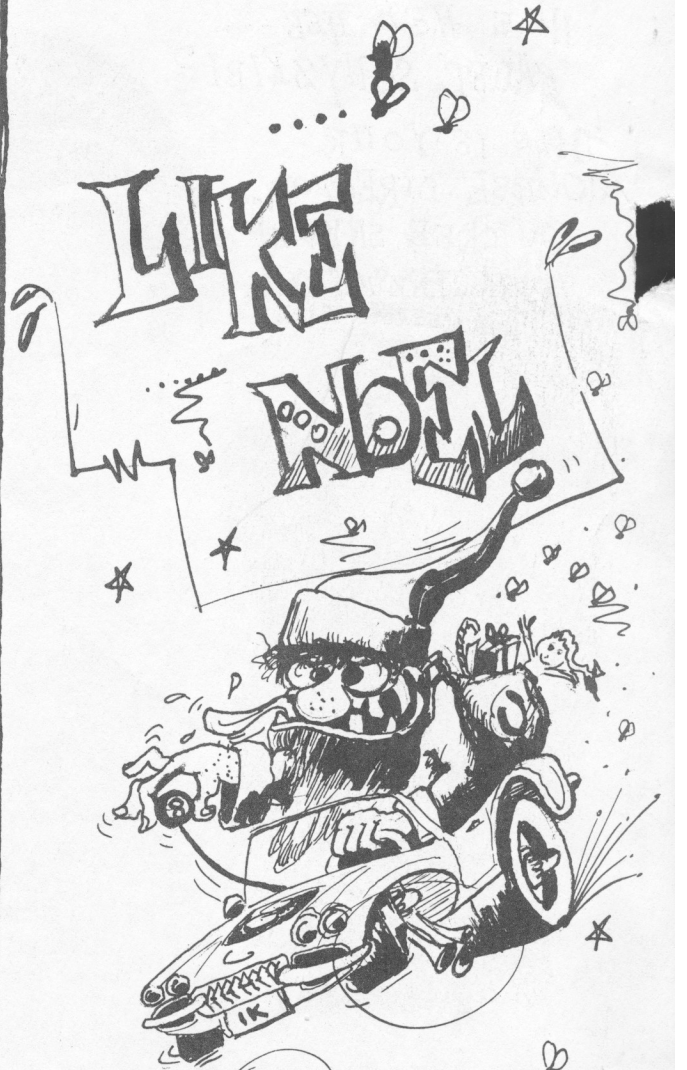

PART II OF "DOCTOR! NO!" A J. WELLINGTON BONDS MYSTERY

(As we left our hero, the evil villain, Thomas P. Mac Beth was in the process of sticking Bond's arm full of evil flu serum. Bonds, with his partner, Tinkerbelle, of the CIA, ferry division, had invaded the dispensary in search of the villain and the kidnapped cadet. Bonds slipped on the floor and awoke to find himself in the above predicament.)

Just as the needle slipped into the arm, the lights went out. A little pinpoint of light sped across the room...a CCRRAAASSSHHH...a scream...a gurgle of flu serum...The lights came back on to reveal the cadet pouring water on Bonds and T.P.M. on the floor, needle in his arm, screaming to the heavens about the injustice of it all. "I'll have you all put on report for this...I promise you that, or my name isn't Thomas P. MacBeth, arch fiend!"

Bonds awoke and looked at the lights. Seeing Tinkerbelle, he smiled his most noble heroic smile. "Jolly good show, old girl, how did you manage the trick with the lights... so well timed, I might add."

"The switch, idiot! You got any better ideas on how to turn out the lights?"

"Ah, the switch...the switch. Good thinking....Oh, noble switch, upon the wall, the noblest switch of them all, when I look at you, my stomach goes kickitypoo, to think of my hours of torment, but for you. Oh switch, Oh switch, so noble and true, what would one do, without you..."

"Go without lights....YYUUCCGGHH. Has anyone ever said that you were really hurtin' to your face..."

"But of course not, my dear. It seems highly implausible that a man of my superior talents would ever get such a crass remark. Why, I remember...say, it is about time for the bar scene, isn't it?"

"It WAS, baby, but you just ran out the money for the low cost script...you know, operation bottom penny. Now blow..."

Tinkerbelle flew out the window...suddenly there was an uproar that resounded throughout the chilled winter air...a crash...a scream. Bonds bolted out the window to see a little spot of light spinning lazily to the ground below...a trail of smoke followed and wrote an obituary on the snow...Tinkerbelle was gone.

Above the flagpole Bonds saw a two masted schooner floating lazily in the breeze, smoke lifting from one of its cannons. A little man with a mustache on his face and a hook in his hand (it would be difficult for this to be reversed) laughed craftily. Bonds shook his fist and cursed...SLUSH had struck again.

The air was shattered with blinding crash...the boat disappeared in a puff of black, evil smoke. Captain Hook had forgotten about Peter Pan...a fatal mistake... the high speed projectile with GL69 decay killer had disintegrated the ship. Bonds watched the little green boy disappear into the sunset as he thought of the constant trade between the agent of the evil, mean, bad, nasty SLUSH and the good guys. Head between his feet, he slowly climbed back to his post on Olympus.

He walked into the office. His secretary greeted him with a smile. Somehow the Berretta on her hip did not do anything for her. Perhaps if it were gold with a pearl handle...he thought about asking 2908 about that...perhaps material could do something about this problem. Besides, with Tinkerbelle gone, he might have to do the bar scene with his secretary. Bonds went through the usual procedure...he showed his I.D., his defense Emergency card, his mother's picture, and his cadet chargeplate. His secretary led him into a small room which was off of his office. She pressed a button, and spoke into a microphone: "AUNT CONTROL, THIS IS SPASTIC...CODE GREEN...IN PLACE FOR TRANSMISSION." A screen on the wall lit and W's sour complexion came into view. "Bonds,

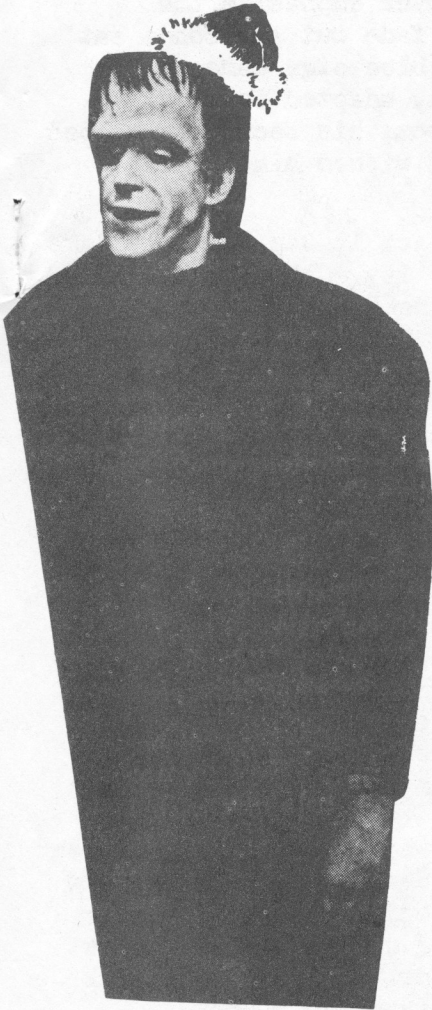

I have a job for you. You will proceed immediately to area 35K69S-45R and investigate subversion of essential instillations in this area...I cannot over emphasize the essential and confidential nature of your mission." W went to fade out and Bonds sat intently watching the cartoon that followed. A large gold and blue sign came on the screen -- "This has been a Warner Von Brown Brothers Production, adapted for T.V. secret microwave transmission by..." Bonds went out from the room; his secretary helped him strap on his ski boots, handed him his number five gun, and wished him well.

#### NORTH POLE

Bonds touched down in a small lake area. As a matter of fact it was the only lake within three hundred miles and he landed right in the middle of it. Climbing out of the lake onto the ice was pretty difficult, but he made it. (The Polar Bear that was swimming after him helped). On the horizon there was a whirr. He looked up as a stranded plow affair came over the horizon. A little bear popped out of the top with a box of cereal under one arm and drew his gun from his cowboy suit. BLAP. Bonds suddenly felt sweet all over. A great vacuum swept him into the machine and he was off.

Later, in a little candy stripped house, he awoke, feeling his usual hungover self. He saw all sorts of mixing vats of red and white around him with little men working on them...he thought he could smell something...toothpaste. Yes, it was toothpaste. He tapped the other man in the cell, who looked up and confirmed this. Bonds asked him who he was, but did not get the answer...the man was examining his teeth. Bonds glanced at the "M.D." on the man's black coat. After three hours of working on his teeth, the man grinned. Bonds whole mouth felt like it had been the percussion section of a symphonic orchestra playing the 1812 Overture...Bonds asked to who he was indebted for the service and the man gave him his card: "Mr. Decay. You grow 'em, I mow 'em, Help stamp out <sup>34%</sup>!" Bonds did not have the heart to tell the man he had had all of his teeth knocked out three years before and the man had been working on a realistic set of dentures.

The next morning Bonds was dragged from the cell by a man who was naturally dressed in subversive red. He was taken to a little house outside the compound. He walked in and was greeted rather jovially by a big, jolly gentleman with white whiskers who was laughing as he fit the brass knuckles on his hand. Bonds walked up and stuck out his hand..."Bonds is my name...Department of Mechanics Secret Service." A toy rattlesnake jumped up and bit him. The old man laughed. "Do you know who I am, Mr. Bonds?" "Santa Claus?" asked Bonds.

"That used to be what I was called, along with Saint Nick and many other titles, but I changed my name to Mr. Large since I joined SLUSH."

"AHA, SLUSH!" I know they would be involved. And, what dastardly plot did they use to get you to join their evil, bad, nasty, mean organization?"

The old man got a glint in his eyes and his cheeks got a little bit rosier. "Dastardly plot, Mr. Bonds? This may surprise you, with your organization's outstanding knowledge of SLUSH, but I started SLUSH. I suppose that makes me the head of it, does it not?"

Visions of sugar plums and hand grenades ran through Bonds' head. He took a deep breath. "But why, you were such a good man. What made you do such a thing?"

"Mr. Bonds, have you ever heard of being too good. I got so sick of it. I grew tired of all the letters, of making everybody so happy. I was so sick of dodging kids who wanted to see Santa Claus leave their toys that they asked for. Then, I realized that I was, because of dodging brats, becoming very good at being sneaky. I was sitting in a department store one day and a little brat walked up and kicked me. On my knee, where he committed the act, there was a mark of sluch on my trousers. It was then I got the idea for a truly vile organization."

Bonds was dizzy. Such a brutal plot. He spun around, and what did he see tied up over in the corner...Tinkerbelle. Bonds looked at Santa Claus. "But, I saw her go down in flames!"

"Captain Hook was one of my best agents, Mr. Bonds, but he failed. It takes a lot to keep a good fairy down!"

"But, Mr. Large, why, if you have changed your activities, have you continued to make toys for the kiddies? Do you plan to be a double agent of good AND bad?"

"Examine these toys a little more closely Mr. Bonds. An atomic bomb erector set that really works, a toy rattlesnake that spits real venom, pistols that shoot real bullets, a Tinkerbell Doll that will attack anyone the owner pleases, and academics kits ~~full~~ of assorted finals to drive anyone mad, and toy ballons that dispense real poison gas when they explode. I will pass these out at Christmas and the whole world will be in havoc. Do you think parents will be able to discipline their children? No! The kiddies will run the world, and as their idol, I will be their leader. You will be Emperor of the Earth. Now Mr. Bonds, I am afraid that, since you stumbled into my setup, I must take some corrective measures. What would you like to play with?"

Bonds looked around. He felt trapped. What to do. He saw the elves working on the toys. Suddenly the thought came to him. Thomas P. MacBeth was in SLUSH. That would make Thomas P. MacBeth one of Santa's helpers!

THE DODO, ITS CREATIONS STAFF, AND THE BROTHERS, BONDS, WISH YOU A MERRY, LIQUID CHRISTMAS, AND A ROLICKING FROLICKING NEW YEAR. A SPECIAL WISH FROM THE DODO TO G. ROBINSON (GEORGE) BONDS FOR A QUICK RECOVERY. ALSO A SPECIAL MERRY CHRISTMAS TO THE DEAN.





E60-10  
T 13

# THE DODO SPORTS SCOPE

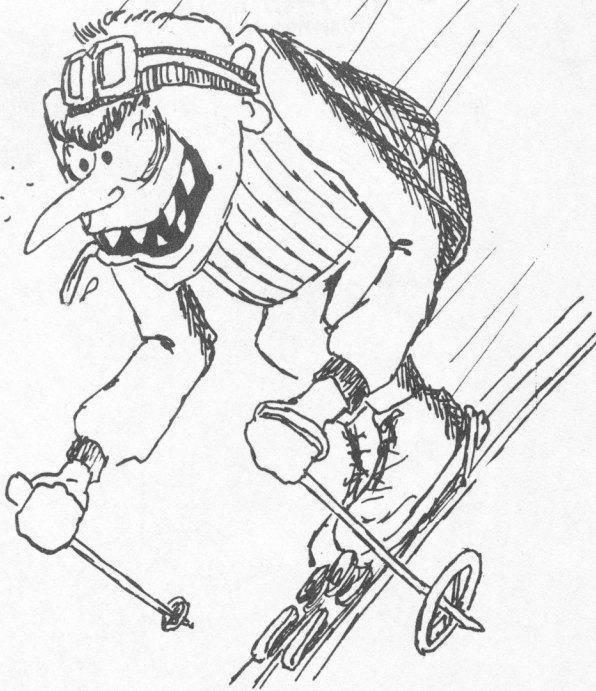

Considering the competition though, these sacrifices seem necessary. CU's "Olympic Alpine team" is ready for a big season, and DU is always very strong in all events.

A note for the future is the presence of Larry Funk on this year's frosh team. Funk was one of the nation's top Alpine juniors before coming to the Academy. He is potentially the best skier in the history of the AFA. Duke got some new boots.

Moving indoors to the basketball court finds the Falcons with a 1-2 record, but a big improvement can be expected as the season progresses. Though both games were lost at the Mile High Classic last week-end, CSU, the tourney champs, barely beat the Falcons in overtime. This year's team is young and still relatively inexperienced. Scott Etnyre, Jerry Yankee, and Ed Sullivan and much used reserve Marty Andrade are all juniors. Fred Budinger a probable starter, is a sophomore. As experience is picked up the Falcons should develop more consistency in their attack. The short walk to the gym should be very worthwhile for basketball followers this season.

Although there is no varsity team yet, the sport of snow and ice driving has gained a lot of support here at the Academy. The road maintenance crews are solid backers of this sport, and one can usually find a good course right on the Academy grounds anytime within a month of the last snowfall.

The sports staff would like to throw in a few Christmas gift suggestions from the athletic world. You might get your old lady a new pair of combat boots to wear for runs to the corner grocery store. How about a USAFA T-shirt and a new set of cleats for your girl. You could easily win your fathers favor with a set of magnesium competition knitting needles. And as a gift for anyone involved in competition shooting check into the latest line of fine weapons by Daisy.

Lastly, the Dodo Sports Staff's gift to our readers -

Skiing season is once again here, and for the Academy varsity sports program this is good. The team this year appears better than any before. Team captain, Kent Waterman, heads the list of returnees. He is backed by Jerry Allen, Scott Duncan, Paul Storaasli, L. Luebke, Bob Putnam, Paul Larsen and Al Danes in the downhill and slalom. Storaasli, Allen, Putnam, and George Sherman join Waterman in the Nordic events, Jumping and cross-country (9 miles worth). Six meets comprise this year's schedule. Four of these are in the Colorado area. The other two are in Reno, Nevada and Park City, Utah.

The skiers are giving up a large part of their Christmas leave to come back to Colorado to get in four days of practice at Winter Park before their first meet of the season at Steamboat Springs on the 1st of January. It seems that a note of appreciation is due here for the sacrifice of a good deal of leave and New Year's Eve party time.

J\*JET

# the **Dob** Our Only Medicine

Prof: "I may be mistaken but I thought you were talking during class."  
 Student: "You must be mistaken. I never talk in my sleep."



## THE TEST

The fog  
 Comes  
 On little cat feet  
 As you sit for a test  
 And sits  
 On silent haunches  
 Hovering over every desk  
 And then moves on-  
 Only sometimes, it doesn't.

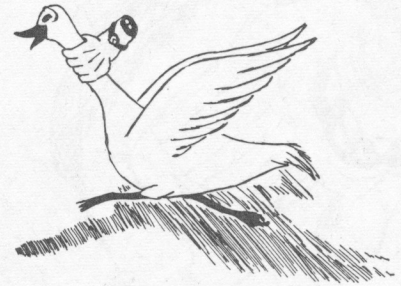

STEWART '65

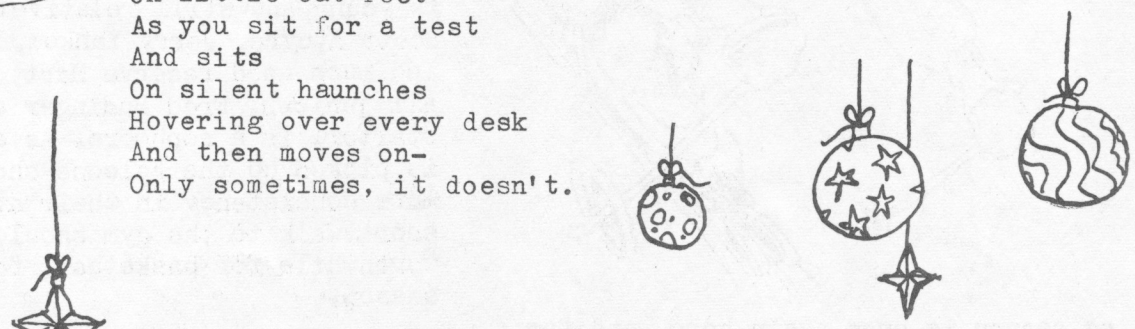

JLR

He only drinks to calm himself  
 His steadiness to improve.  
 Last night he got so steady  
 He couldn't even move.



"THIRD MAN FROM THE END, UNSHINED SHOES."





from the editor.....

Somehow, in the next fifteen minutes, I've got to fill up this page. By printing in oversized letters and sticking in ridiculous pictures... first, a little about this issue. The cover can be attributed to the collectors save a skull of good junk (who'd ever and a bit and a 50-IRI alpha cap?) New artists of excellent photography. for pages' and contributors account for pages' 2 and 15. Another chop at J. Wellington Bonds and arch fiend MacBeth make a long issue longer, and we've attempted to help you in your finals and last minute shopping. For the sports car enthusiasts and others who like a fast ride, the new specs on one tough machine can be found on page 13. What better way to round out <sup>the</sup> semester's last Dodo than with Elke Sommer and our Christmas Spacemate? That about kills it, except to wish all a Merry Christmas and no turnout.

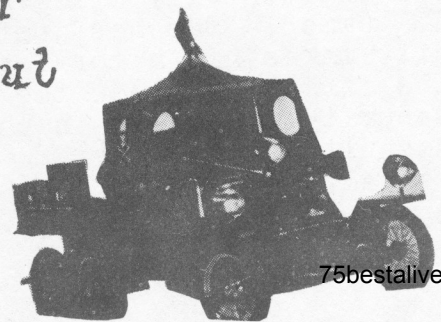
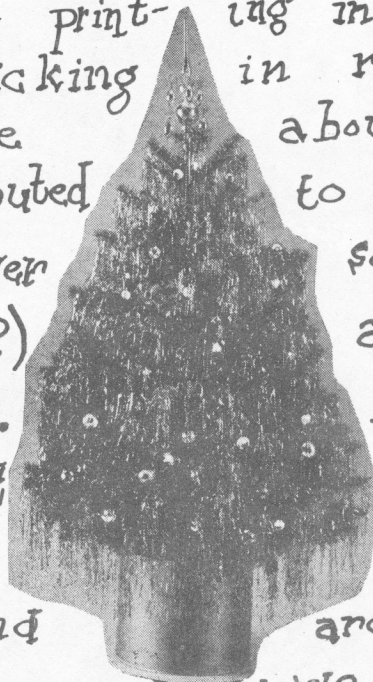

dmc

**DODO READERS!** We of the staff were unable to accumulate the Approved Solutions this year for any of the finals or turnouts. But don't despair, yet. Below are copies of the most often asked questions in every major area of academic endeavor and we of the staff are presently working frantically to find the answers. They will be forthcoming in a more expensive version of the Dodo before the turnouts. Otherwise...bye bye staff.....

1. Given: Diagram at left.

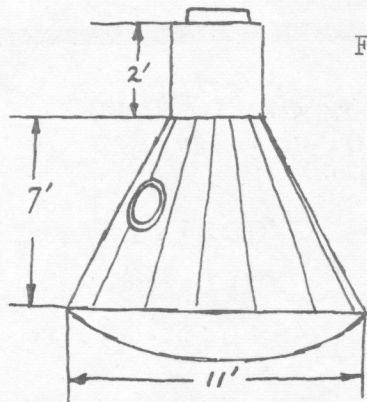

Find: The following.

a) Derive the elements of orbit, the hyperbolic excess velocity, the Hohman transfer parameters, and  $\theta_{bo}$  to strike the Yorktown somewhere in the Pacific during a max speed cruise.  $V$  of the Yorktown is 2 knots.

b) Using the derived equations and these values:

$$R_{16} = 12.73513 \text{ DU}$$

$$\theta_0 = 3643^\circ$$

$$G_{RF} = 4,6173 \text{ CU}$$

Calculate all other pertinent data.

2. In the four blue books provided, discuss:

a. The world situation and its ramifications since the diplomacy of Atilla the Hun.

b. Why Cuba hates us and why we shouldn't neuc them.

Swahili, Africa has received 4 trainloads of TV sets from the USSR whose MPP is  $\int mc^2 d\omega + E$  and GNP is  $\frac{4A}{F} g'g'' \Delta A$ . Swahili is located behind Mt. Chobie (el. 27,972.0001 ft. ) 2500 miles away in Jerusalem. Additional information: 1. Swahilians are practicing Muslims. 2.  $E = 49 \times 10^{-12.4}$  farads/capita. 3. The first show is to be Handel's Messiah as interpreted by Karl Marx and the Rand Corp. 4. The answers are the same as those under question 4, Econ final-Dec. 1960, and essay question 2, EE final-May 1956.

1. How many rabbit ears should the US send to Swahili if reception is limited to those homes with band widths of  $P' = \frac{E}{c^2 v} \cdot \frac{1}{v}$  ?

A. Obviously 4 trainloads. (watch this one!) B. The Peace Corps does not allow TV. C. None of the below. D. All of the above. E. jwc. F. C&D.

2. (True or False) The Econ Dept. knows the answer to the above question.

Assume no additional facts, apply the majority rule in all cases and spell out T and F.

Sexless accidentally discovered that his motel room bath is shared with Elk A. Summer. She has just come in from a negligent party whose legal capacity makes him a tortfeasor. What is the remedy if:

1. She forgets to lock the bathroom door and he has strict liability for security interests in personal property?

A. Assault and Battery. B. All of the above.... C. Waeshe v. Falsetto Hts. et al, CDB, USAFA, 156, (1964) D. Pursuit and Capture. E. He has rights of compromise decision. F. She is community property.

MILITARY HISTORY: General Instructions---This is an open-mouthed test. Allow jaw to hang accordingly. There are 200 objective, 17 essay questions, worth 2,000 points. After reading these instructions, spell Maj. Hayes' name correctly for 5 points.

ESSAY #1) Describe the characteristics of Hannibal's elephants, including the significance of pachyderms as opposed to Rocky Mountain chipmunks, and their advantages and disadvantages in the Alps.

PHYSICS: General Instructions---Read the problems. This is a closed-mind test. Think accordingly. Slide rules, CWC's, and brains may be used to equal disadvantage. Each of the 70 problems is worth 100 points- those you miss, 300 points.

(I) Calculate the rotational inertia of Maj. Scisyhp's left eyeball as he looks from his rubber-tipped pointer, (mass=252.2 g), to the 574th metal square in the lighting system from the back of the room. Assume 20 sphincter muscles and two whattyacallits do the vertical and horizontal action on the eyeball.

(HINT:) The instructor has muscular dystrophy.

BEH. SCI.(GENERAL PSYCHOLOGY): General Instructions---This is a closed-mind, open-mouthed test. Flunk accordingly. No extra help, such as pencils, IBM sheets, erasers, etc. will be allowed. Your response to this avoidance-avoidance conflict will be graded through the use of hidden cameras. You have 90 minutes. There are 1500 questions, total 1000points, (2/3 apiece); motivate when the instructor so stimulates.

(I) PSYCHOLOGY classes, in general;

a)Hurt

b)Help

c)Both

d)Either one or the other two, in the event of psychosis.

PHYSIOLOGY: If the partial pressure of  $O_2$  in the alveoli is 81.34 mm Hg and of  $CO_2$ , 43.19 mm Hg, considering the water vapor pressure constant at 47 mm Hg, the bronchioles are constricted by 27%. What effect would an exaggerated synaptic delay, due to acetylcholine lack, and leading to failure of the tectospinal tract to properly relay sensory impulses to the thalamus, have on an aerospace cadet's capability to get to Pete Field in time to catch his hop?

- A. The motor response dictated by the thalamus would also fail, instilling in the cadet an inordinate desire to remain and sacrifice his seat on the hop to his element leader.
- B. His reflex arc would be incomplete, leaving him incapable of movement.
- C. "To hell with the thalamus- full speed ahead!"

ENGLISH: Answer either of the following two questions.

1. In a paragraph of 25 words or less (wordiness, verbocity, and redundancy will be penalized) compare and contrast, with frequent illustrations from the text, the social, moral, psychological, and intellectual reasons for, exposition of, and results stemming from: "Catcher in the Rye," "Adventures of Huckleberry Finn," "The Miracle of Language," "A Farewell to Arms," "The Grapes of Wrath," and "Light in August."

2. Do you agree with Frederick Henry's policy on free love? If so, why?

THE DODO, with its hurtin' budget and really bent staff, in attempting to copy a nationally known publication for cadets, has decided to push a few not too well known brands, to make your shopping a little easier and, with a jaundiced eye toward kickbacks, to make ours a whole lot easier. Here then are our ideas of the Perfect Gifts for Christmas, 1964.....



A. Christmas Choir Boys decoration for your front lawn. Life sized figures.....\$\$\$\$.¢¢

C. New brand of compact. Real economy without a sacrifice of performance. Your dream car, convert or fastback.....Special Deal for Cadets

D. NATO safes. COSMIC secrets, used recall signals.....1 ID Card & 27 rubles

E. USAFA-poo Joy Juice, from fine overhead locker distilleries.....80/120

F. Toy Russian missile w/launch crew. Programs for New York, Chicago, Memphis, and Tucson. Specify which....Cheap from Manufacturer

# The Year of the Fast Ones<sup>\*</sup>...

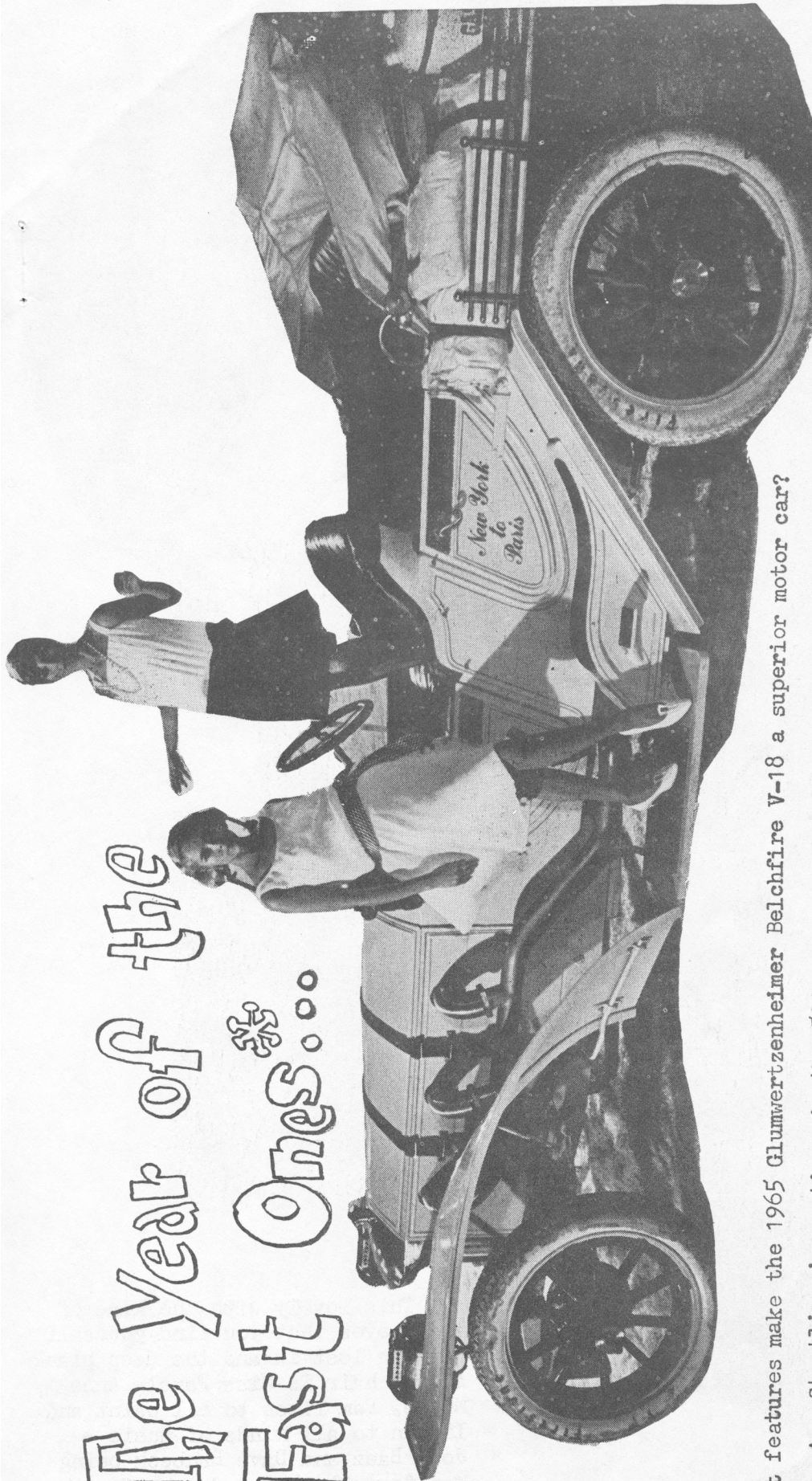

Q. What features make the 1965 Glumwertzenheimer Belchfire V-18 a superior motor car?

- A. Startling innovations in the 593 cu. in. mill, plus its 7 Latham-blown 2 bbl carbs, straightpipes, and 400 volt battery; 11 inches of foam padding in all seats, with only the finest Tanganykan leather and Peruvian Mohair in the upholstery, and only the finest walnut in the dash and steering wheel; a 60-watt amp with the most advanced turntable, tapedeck, and AM-FM tuner in an integrated stereo-TV-bar unit available.

Q. Is it possible to obtain any other accessories with this truly superior motor car?

- A. Yes. Optional equipment includes the Firerock Red Lines shown. Also two portable heaters.....

\* Available at your Glumwertzenheimer dealer's today.

THE  
Doob  
SPACEMATE



This lovely with the kind of green eyes that you find yourself getting lost in and the deep black-auburn hair is Miss Pamela Anne Moore. Pam likes to oil paint and listen to all kinds of music - Joan Baez and Dave Brubeck being her favorites. She dances for the Rocky Mountain National Ballet Company and is the friend of C/3C Ray S. Morton, Nineteenth Squadron.

# MERRY CHRISTMAS FROM THE STAFF

